



60x60x15 mm SERIES

GENERAL SPECIFICATIONS

Frame&Impeller Material: Plastic(UL 94V-0)

Bearing Type: B: Dual ball bearing

S: Sleeve bearing

Lead Wires: UL 1007 AWG#26 OR Equivalent

Red Wire Positive(+)

Black Wire Negative(-)

Weight: 32g(1.13oz)

DIMENSIONS DRAWING

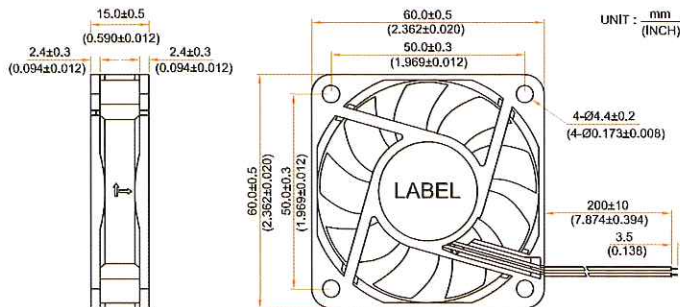

P-Q CURVE

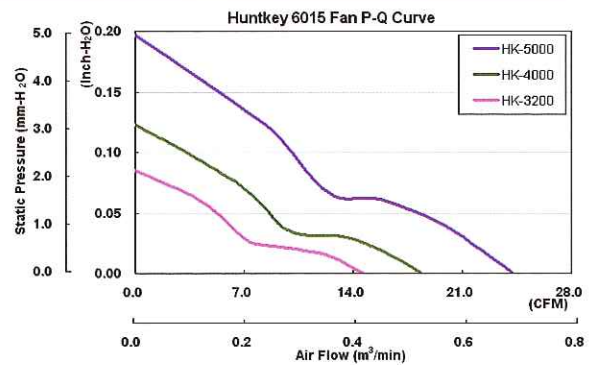

MODEL	Rated Voltage	Operating Voltage Range	Rated Current	Rated Input Power	Speed	Maximum Air Flow	Maximum Air Pressure	Noise		
PART NO.	VDC	VDC	Amp	Watt	R.P.M.	m ³ /min	CFM	mm-H ₂ O	Inch-H ₂ O	dB-A
AS6015L12	12	5.0 to 13.8	0.08	0.96	3200	0.415	14.64	2.17	0.085	28.2
AS6015M12	12	5.0 to 13.8	0.13	1.56	4000	0.520	18.37	3.13	0.123	31.9
AS6015H12	12	5.0 to 13.8	0.24	2.88	5000	0.686	24.21	5.01	0.197	39.4

*Function type is optional.

*The max. air flow and the speed are measured in free air; max. air pressure is measured at zero air flow.

*Noise is measured in anechoic chamber in free air, one meter from intake side.

*All readings are typical values at rated voltage.

*Specifications are subject to change without notice.

HUNTKEY ENTERPRISE GROUP

Add: Huntkey Industrial Park, Banxue Road, Bantian, Shenzhen, 518129, China

Tel: +86-755-89606666 Fax: +86-755-89606333 E-mail: markets@huntkey.com

Website: www.huntkeydiy.com www.huntkey.com

All rights reserved.

All images are for reference only!